



INVERTER

Option unit

FR-LU08

FR-LU08-01

INSTRUCTION MANUAL

LCD Operation Panel

PRE-OPERATION INSTRUCTIONS	1
FUNCTION AND BASIC OPERATION	2
MENU	3
CHECK FIRST WHEN YOU HAVE TROUBLE	4
SPECIFICATIONS	5

Thank you for choosing this Mitsubishi Electric inverter option unit.

This Instruction Manual provides handling information and precautions for use of this product. Incorrect handling might cause an unexpected fault. Before using this product, always read this Instruction Manual carefully to use this product correctly.

Please forward this Instruction Manual to the end user.

Safety instructions

Do not attempt to install, operate, maintain or inspect the product until you have read through this Instruction Manual and supplementary documents carefully and can use the equipment correctly. Do not use this product until you have a full knowledge of this product mechanism, safety information and instructions. In this Instruction Manual, the safety instruction levels are classified into "Warning" and "Caution".



Warning

Incorrect handling may cause hazardous conditions, resulting in death or severe injury.



Caution

Incorrect handling may cause hazardous conditions, resulting in medium or slight injury, or may cause only material damage.

The  level may even lead to a serious consequence according to conditions. Both instruction levels must be followed because these are important to personal safety.

◆ Electric shock prevention



Warning

- Do not remove the front cover or the wiring cover of the inverter while the inverter power is ON. Do not operate the inverter with any cover or wiring cover removed, as accidental contact with exposed high-voltage terminals and internal components may occur, resulting in an electrical shock.
- Do not remove the inverter front cover even if the power supply is disconnected. The only exception for this would be when performing wiring and periodic inspection. You may accidentally touch the charged inverter circuits and get an electric shock.
- Before wiring or inspection, LED indication of the inverter unit operation panel must be switched OFF. Any person who is involved in wiring or inspection shall wait for at least 10 minutes after the power supply has been switched OFF and check that there is no residual voltage using a tester or the like. For some time after the power-OFF, a high voltage remains in the smoothing capacitor, and it is dangerous.
- Any person who is involved in wiring or inspection of this product shall be fully competent to do the work.
- Do not touch the operation panel or handle the cables with wet hands. Otherwise you may get an electric shock.
- Do not subject the cables to scratches, excessive stress, heavy loads or pinching. Otherwise you may get an electric shock.

◆ Additional instructions

The following instructions must be also followed. If the product is handled incorrectly, it may cause unexpected fault, an injury, or an electric shock.



Caution

Transportation and mounting

- Do not install or operate the operation panel if it is damaged or has parts missing.
- Do not stand or rest heavy objects on the product.

Caution

Transportation and installation

- The mounting orientation must be correct.
- The surrounding air temperature must be between -10 to +50°C (non-freezing). Otherwise the inverter may be damaged.
- The surrounding humidity must be 90% RH or less (non-condensing) for the FR-LU08, and 95% RH or less (non-condensing) for the FR-LU08-01. Otherwise the inverter may be damaged.
- The storage temperature (applicable for a short time, such as during transit) must be between -20 to +65°C. Otherwise the inverter may be damaged.
- The inverter must be used indoors (without corrosive gas, flammable gas, oil mist, dust and dirt etc.) Otherwise the inverter may be damaged.
- Do not use this product at an altitude above 2500 m. Vibration should not exceed 5.9 m/s² at 10 to 55 Hz in X, Y, and Z directions. Otherwise the inverter may be damaged.
- If halogens (including fluorine, chlorine, bromine, and iodine) contained in fumigants for wood packages enter this product, the product may be damaged. Prevent the entry of fumigant residuals or use an alternative method such as heat disinfection. Note that sterilization of disinfection of wood packages should be performed before packing the product.

Trial run

- Before starting operation, each parameter must be confirmed and adjusted. A failure to do so may cause some machines to make unexpected motions.

Warning

Usage

- Since pressing the STOP/RESET key of the operation panel may not stop output depending on the function setting status, separate circuit and switch that make an emergency stop (power OFF, mechanical brake operation for emergency stop, etc.) must be provided.
- OFF status of the start signal must be confirmed before resetting an inverter fault. Resetting an inverter fault with the start signal ON restarts the motor suddenly.
- Do not modify the equipment.
- Do not perform parts removal which is not instructed in this manual. Doing so may lead to fault or damage of the product.

Caution

Usage

- When parameter clear or all parameter clear is performed, the required parameters must be set again before starting operations because all parameters return to the initial value.
- Static electricity in your body must be discharged before you touch the product.

Disposal

- The product must be treated as industrial waste.

General instruction

- Many of the diagrams and drawings in this Instruction Manual show the inverter without a cover or partially open for explanation. Never operate the inverter in this manner. The cover must be reinstalled and the instructions in the Instruction Manual must be followed when operating the inverter.

Caution

Waterproof and dustproof performances of FR-LU08-01

- When securely fixed to the inverter with screws, the operation panel (FR-LU08-01) is rated IPX5*1 waterproof rating and IP5X*2 dustproof rating.
- The items enclosed with the FR-LU08-01 such as the Instruction Manual are not rated with the IPX5 waterproof or IP5X dustproof ratings.
- Although the FR-LU08-01 (except for the connector) is rated with the IPX5 waterproof and IP5X dustproof ratings, it is not intended for use in water. Also, the ratings do not guarantee protection of the FR-LU08-01 from needless submersion in water or being washed under strong running water such as a shower.
- Do not pour or apply the following liquids over the FR-LU08-01: water containing soap, detergent, or bath additives; sea water; swimming pool water; warm water; boiling water; etc.
- The FR-LU08-01 is intended for indoor*4 installation and not for outdoor installation. Avoid places where the FR-LU08-01 is subjected to direct sunlight, rain, sleet, snow, or freezing temperatures.
- If the screws of the FR-LU08-01 are not tightened, or if the FR-LU08-01 is damaged or deformed, the IPX5 waterproof performance and the IP5X dustproof performance are impaired. If any abnormalities are found on the FR-LU08-01, ask for an inspection and repair.
- To maintain the waterproof and dustproof performances of the FR-LU08-01, daily and periodic inspections are recommended regardless of the presence or absence of abnormalities.

- *1 IPX5 refers to protection of the operation panel functions against water jets from any direction when about 12.5-liter water*3 is injected from a nozzle with an inside diameter of 6.3 mm from the distance of about 3 m for at least 3 minutes.
- *2 IP5X refers to protection of the operation panel functions and maintenance of safety when the inverter is put into a stirring device containing dust of 75 µm or smaller in diameter, stirred for 8 hours, and then removed from the device.
- *3 Water here refers to fresh water at room temperature (5 to 35°C).
- *4 Indoor here refers to the environments that are not affected by climate conditions.

— CONTENTS —

1	PRE-OPERATION INSTRUCTIONS	7
1.1	Unpacking and checking the product	7
1.1.1	SERIAL number check	7
1.2	Major differences between the FR-LU08 and FR-LU08-01	9
1.3	Appearance and parts name	10
1.4	Installation and removal	12
1.4.1	Installing the operation panel on the inverter (FR-A800/F800)	12
1.4.2	Connecting the operation panel using a connection cable (FR-CB2)	14
1.4.3	Installation of a backup battery	16
1.5	Initial setting	17
1.5.1	Language selection	17
1.5.2	PU buzzer control (Pr.990)	17
1.5.3	PU contrast adjustment (Pr.991)	17
2	FUNCTION AND BASIC OPERATION	18
2.1	Monitor function	18
2.1.1	Outline of the Main monitor indicator	18
2.1.2	Using the real time clock function	21
2.1.3	Switching between the Main monitor screen and the Menu screens	21
2.1.4	Changing the Main monitor screen	22
2.1.5	Changing the main monitor item from the Function menu	23
2.1.6	Changing the main monitor item by parameter	23
2.1.7	Setting of the monitor data screen at power-ON (first priority monitor)	23
2.2	Frequency setting	24
2.3	Direct setting	25
2.4	Fault history indicator	26
2.5	Setting and changing the parameter values	27
2.5.1	Specifying the parameter number to change the set value	27
2.5.2	Selecting the parameter from the Function group menu to change the set value	28
2.5.3	Selecting the parameter from Function menu to change the set value	29

2.5.4	Precautions for writing the set value	30
2.5.5	Displaying parameter descriptions (parameter information)	30
3	MENU	31
3.1	Quick menu	31
3.1.1	Easy setup wizard	31
3.1.2	Parameter list by application	32
3.1.3	Simple setup list	33
3.2	Function menu	34
3.2.1	Parameter clear	35
3.2.2	Inverter reset	35
3.2.3	Terminal assignment	35
3.2.4	Parameter copy	36
3.2.5	Option installation monitor	38
3.2.6	USB memory	39
4	CHECK FIRST WHEN YOU HAVE TROUBLE	46
4.1	Troubleshooting	46
5	SPECIFICATIONS	47
5.1	Standard specifications	47
5.2	Outline and enclosure cut dimensions	48
	Appendix	49
Appendix 1	Disposing of equipment in EU countries	49
Appendix 2	Instructions for compliance with the EU Directives	50
Appendix 3	Instructions for EAC	51
Appendix 4	Restricted Use of Hazardous Substances in Electronic and Electrical Products	52



1 PRE-OPERATION INSTRUCTIONS

1.1 Unpacking and checking the product

Take the operation panel out of the package, and confirm that the product is as you ordered and intact.

The FR-LU08(-01) is compatible with the 800 series inverters.

1.1.1 SERIAL number check

Availability of the FR-LU08(-01) itself and its functions depends on the inverter model. Check the serial number of the inverter to see if the functions below are supported.

- FR-A800/F800/E800



Inverter	Availability of the FR-LU08(-01)		Function		
			Easy setup wizard Parameter list by application (refer to page 31) Direct setting (refer to page 25)		Parameter information (refer to page 30)
	Country-of- origin indication	SERIAL number	Country-of- origin indication	SERIAL number	
A800 series	All		MADE in Japan	<input type="checkbox"/> 55000000 or later	<input type="checkbox"/> 75000000 or later
			MADE in China	<input type="checkbox"/> 56000000 or later	<input type="checkbox"/> 74000000 or later
F800 series	All		MADE in Japan	<input type="checkbox"/> 54000000 or later	<input type="checkbox"/> 75000000 or later
			MADE in China	<input type="checkbox"/> 55000000 or later	<input type="checkbox"/> 74000000 or later
E800 series (except for the FR-E800- (SC)E)	MADE in Japan	<input type="checkbox"/> <input type="checkbox"/> 205000000 or later	Not available		
	MADE in China	All			

Rating plate example

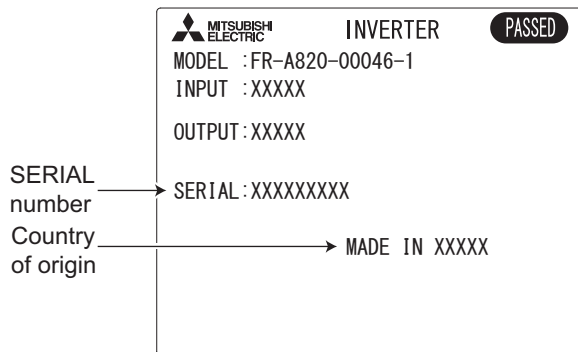
The composition of the SERIAL number differs depending on the inverter. Refer to the Instruction Manual of the inverter to check the SERIAL number description.



1.2 Major differences between the FR-LU08 and FR-LU08-01

Item	FR-LU08	FR-LU08-01
Applicable model	Standard model / Separated converter type	IP55 compatible model
Protective structure	IP40 (except for the PU connector)	IP55 (except for the PU connector)
Outline dimension (W×H×D [mm])	72×78.5×17	80×96×19
Number of fixing screws	2	4
Operation mode indicator	PU/EXT	HAND/AUTO
Operation key	PU/EXT key 	HAND/AUTO key 
Installation on the enclosure	Available	Not available

1.3 Appearance and parts name

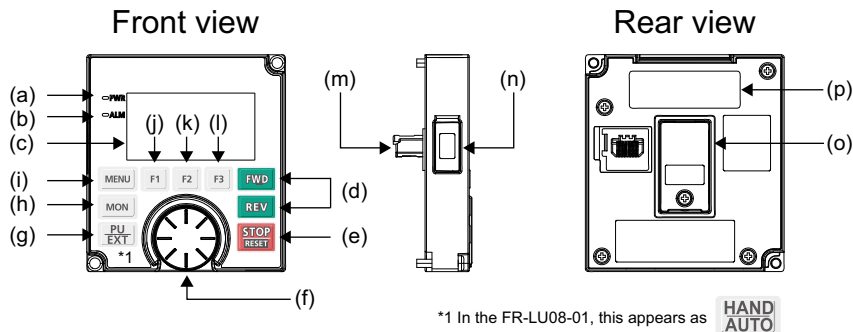

Symbol	Name	Description
a	Power lamp	ON when the power is turned ON.
b	Alarm lamp	ON when an inverter alarm occurs.
c	Monitor	Shows the frequency, parameter number, etc. (Using Pr.52, Pr.774 to Pr.776, the monitor item can be changed.)
d	FWD key, REV key	FWD key: Starts the forward operation. REV key: Starts the reverse operation.
e	STOP/RESET key	Stop operation commands. Reset the inverter when the protective function is activated.
f	Setting dial	Used to change the frequency and parameter settings. Press the setting dial while the fault history is displayed to display the details of the fault. Displays a description of the parameter when the setting dial is held down in the screen for setting parameter values.

Symbol	Name		Description
g	FR-LU08	PU/EXT key	Switches the operation mode between PU, PUJOG, and External.
	FR-LU08-01	HAND/AUTO key	Switches the operation mode between HAND (PU), HANDJOG (PUJOG), and AUTO (External).
h	MON key		Displays the first priority monitor.
i	MENU key		Displays the Quick menu. Displays the Function menu when the key is pressed while the Quick menu is displayed.
j	Software key (F1)		Select an operation displayed on the monitor.
k	Software key (F2)		
l	Software key (F3)		
m	Connector		Connector to the inverter. Connect this connector to the PU connector of the inverter.
n	For manufacturer setting. Do not use. Do not peel off the waterproof seal affixed to the FR-LU08-01.		
o	Battery cover		Remove the battery cover when replacing the backup battery for the real time clock function.
p	Rating plate		-

NOTE

- Do not operate the keys with sharp tools.
- Do not press the LCD part.
- Do not peel off the waterproof seal affixed to the FR-LU08-01. If the seal is peeled off, the FR-LU08-01 does not conform to IP55.

1.4 Installation and removal

For safety, turn OFF the inverter when installing or removing the operation panel.

1.4.1 Installing the operation panel on the inverter (FR-A800/F800)

- Installation

- (1) Remove the operation panel (FR-DU08(-01)) from the inverter. (For the removal of the operation panel, refer to the Instruction Manual of the inverter.)
- (2) Align the connector of the FR-LU08(-01) with the PU connector of the inverter, and insert the operation panel. After confirming that the operation panel is fit securely, tighten the screws. For the FR-LU08-01, tighten the screws in a diagonal order. (Tightening torque: 0.40 to 0.45 N•m for the FR-LU08, 0.39 to 0.49 N•m for the FR-LU08-01)

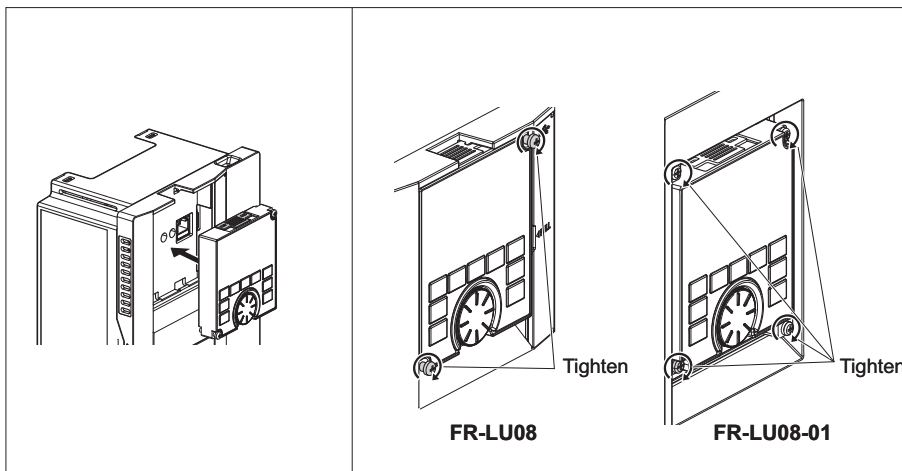

- Removal

- (1) Loosen the screws on the FR-LU08(-01). (These screws cannot be removed.)
- (2) Push the upper part of the FR-LU08(-01), and pull out the operation panel to remove.

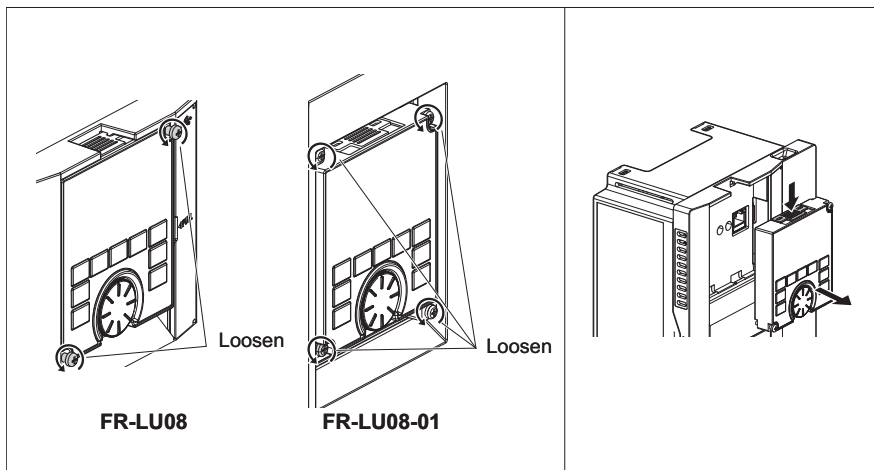

1.4.2 Connecting the operation panel using a connection cable (FR-CB2)

- FR-A800/F800

- Installation

To connect the FR-LU08(-01), an optional operation panel connection connector (FR-ADP) is required.

- (1) Remove the operation panel (FR-LU08(-01)) from the inverter. (For the removal of the operation panel, refer to the Instruction Manual of the inverter.)
- (2) Securely insert one end of the connection cable into the PU connector of the inverter and the other end into the connection connector of the FR-LU08(-01) along the guides until the stoppers are fixed.

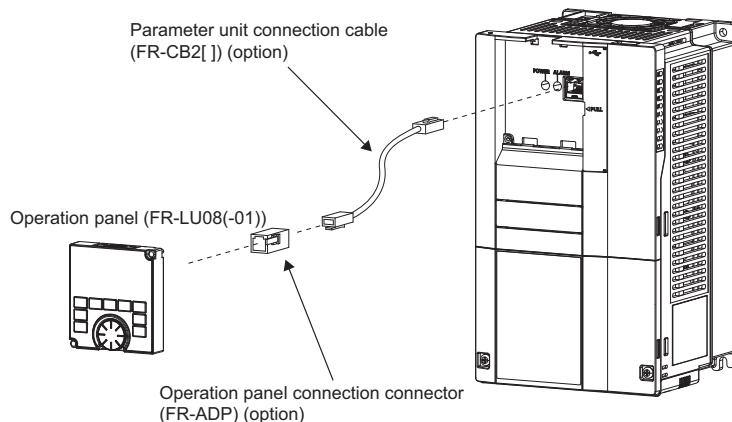

- Removal

Hold down the clip at the cable end and gently pull the connector.



- The IP55 compatible inverter model does not conform to IP55 when the FR-LU08-01 is removed.

- FR-E800 (except for the FR-E800-(SC)E)
- Installation

To connect the FR-LU08(-01), an optional operation panel connection connector (FR-ADP) is required.

- (1) Securely insert one end of the connection cable into the PU connector of the inverter and the other end into the connection connector of the FR-LU08(-01) along the guides until the stoppers are fixed.

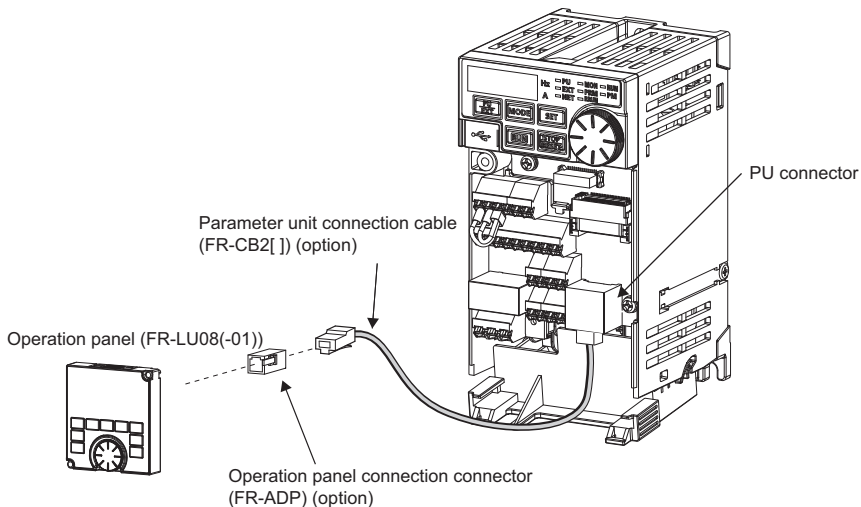

- Removal
- Hold down the clip at the cable end and gently pull the connector.

1.4.3 Installation of a backup battery

With a battery (CR1216), time counting of the FR-LU08(-01) continues even when the main power of the inverter is turned OFF (real time clock function). For the details of the real time clock function, refer to [page 21](#).

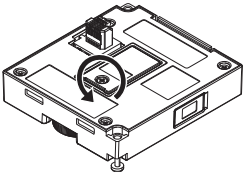
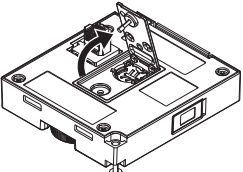
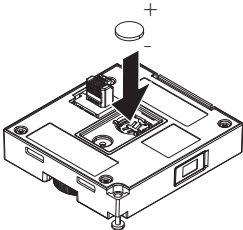
1	Loosen the screw on the battery cover, which is located on the back side of the FR-LU08(-01).	
2	Insert a flathead screwdriver to the slot, and lift the cover to open.	
3	Place the battery as shown in the right figure.	
4	Close the battery cover, and tighten the screw. (Tightening torque: 0.1 to 0.3 N·m)	



NOTE

- Do not replace the battery of the FR-LU08(-01) while power is ON.
- Do not use batteries that have been dropped or otherwise received an impact. Battery leakage may occur. Discard the batteries.

1.5 Initial setting

1.5.1 Language selection

At first power ON, the Language selection screen appears after the corporation logo of MITSUBISHI ELECTRIC.

Turn  to select the language, and push  to set.

The interface language can be changed from the Quick menu.
(Refer to [page 31](#).)



Display Language

English	Turkish
Japanese	Polish
German	Chinese
French	Korean
Spanish	Swedish
Italian	Portuguese
Russian	

1.5.2 PU buzzer control (Pr.990)

With **Pr.990 PU buzzer control**, the beeping sound of the operation panel can be enabled or disabled.

Pr.990 setting	Description
0	Without beeping sound
1 (initial value)	With beeping sound

1.5.3 PU contrast adjustment (Pr.991)

With **Pr.991 PU contrast adjustment**, the contrast of the monitor display of the operation panel can be adjusted.

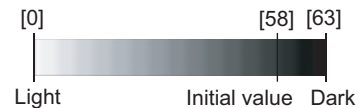
Pr.991 setting	Description
0 to 63	



- For how to set parameters, refer to [page 27](#).

2 FUNCTION AND BASIC OPERATION

2.1 Monitor function

2.1.1 Outline of the Main monitor indicator

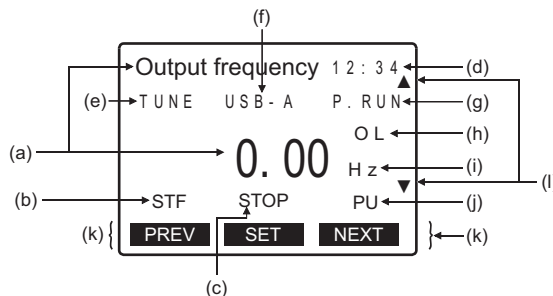

Symbol	Name	Description
a	Main monitor item/data	<p>Displays the output frequency, output current, output voltage, fault history, and others. The Main monitor screen can be changed by the following methods.</p> <ul style="list-style-type: none"> Changing the Main monitor screen using F1 (PREV) or F3 (NEXT) (Refer to page 22.) Changing the main monitor item using the Function menu (Refer to page 23.) Changing the main monitor item using Pr.52 Operation panel main monitor selection (Refer to page 23.)
b	Rotation direction	<p>Displays the direction of the start command ([STF]: forward, [STR]: reverse). ([---] shows that no start command is input, or that both forward and reverse directions are ON.)</p>

Symbol	Name	Description
c	Operating status	Displays the operating status of the inverter. [STOP]: During stop [FWD]: During forward rotation [REV]: During reverse rotation [JOGf]: During JOG forward rotation [JOGr]: During JOG reverse rotation [ALARM]: At fault occurrence
d	Clock	Displays time. With a battery installed, the clock keeps working even if the inverter power is turned OFF. (Refer to page 21.)
e	Tuning status	Displays the offline auto tuning status of the inverter. [TUNE]: During turning or tuning completed [TUNE] highlighted and flashing: Tuning error
f	USB connection/password locked	Displays the connection status of the USB A connector of the inverter and password function setting status. [USB-A]: USB connection recognized [USB-A] highlighted: USB ready [USB-A] flashing: During USB operation [LOCK]: Password locked
g	PLC function/JOG operation	Displays the status of the PLC function and JOG operation. [P.RUN]: During stop with the PLC function enabled [P.RUN] highlighted: During PLC function operation [P.RUN] highlighted and flashing: Operation error in the PLC function [JOG]: JOG operation enabled
h	Warning	Displays an inverter warning.
i	Unit	Shows the unit of the value on the main monitor.

Symbol	Name	Description
j	Operation mode *1	Displays the operation mode. [EXT]: External operation mode [PU]: PU operation mode [EXTj]: External JOG operation mode [PUj]: PUJOG operation mode [NET]: Network operation mode [PU+E]: External/PU combined operation mode
k	Software key	Displays operations performed by pressing the F1 (left), F2 (center), or F3 (right) key.
l	Scroll	Displayed when any data can be scrolled by turning  .

*1 For the FR-LU08-01, AUTO will be displayed instead of EXT, and HAND will be displayed instead of PU in the description of the operation mode indicator.

Operation mode indicator			
FR-LU08		FR-LU08-01	
Indication of EXT/PU		Indication of AUTO/HAND	
<div style="border: 1px solid black; padding: 5px; text-align: center;"> Output frequency 12:34 0.00 Hz - - - STOP EXT PREV SET NEXT </div>	<div style="border: 1px solid black; padding: 5px; text-align: center;"> Output frequency 12:34 0.00 Hz - - - STOP PU PREV SET NEXT </div>	<div style="border: 1px solid black; padding: 5px; text-align: center;"> Output frequency 12:34 0.00 Hz - - - STOP AUTO PREV SET NEXT </div>	<div style="border: 1px solid black; padding: 5px; text-align: center;"> Output frequency 12:34 0.00 Hz - - - STOP HAND PREV SET NEXT </div>

2.1.2 Using the real time clock function

With a battery (CR1216), time counting of the FR-LU08(-01) continues even when the main power of the inverter is turned OFF (real time clock function). For how to install the backup battery, refer to [page 16](#).

- When the battery is installed in the FR-LU08(-01), its time is written to the inverter at power-ON (except the first power-ON after the battery is installed).
- When the battery is not installed, the FR-LU08(-01) reads the time from the inverter and starts time counting.

2.1.3 Switching between the Main monitor screen and the Menu screens

Pressing **MON** or **MENU** switches the monitor display between the Main monitor screen and the Menu screens.

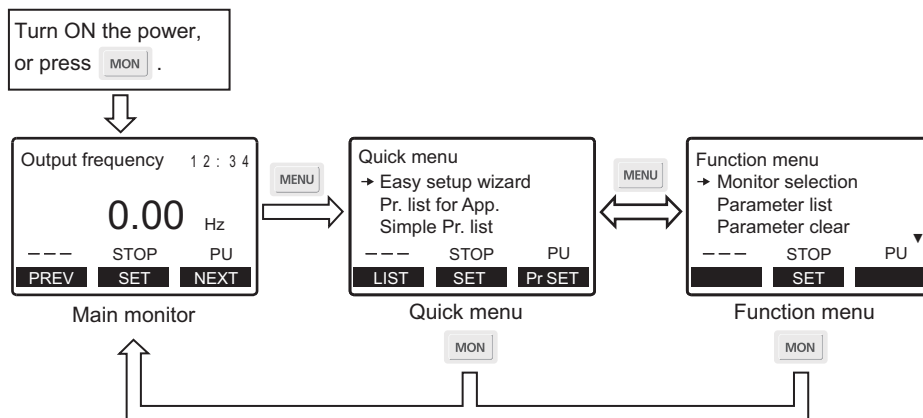

2.1.4 Changing the Main monitor screen

When **Pr.52 Operation panel main monitor selection** is set to "0", 6 types of the monitor screen are displayed in order by

pressing **F1** (PREV) or **F3** (NEXT).

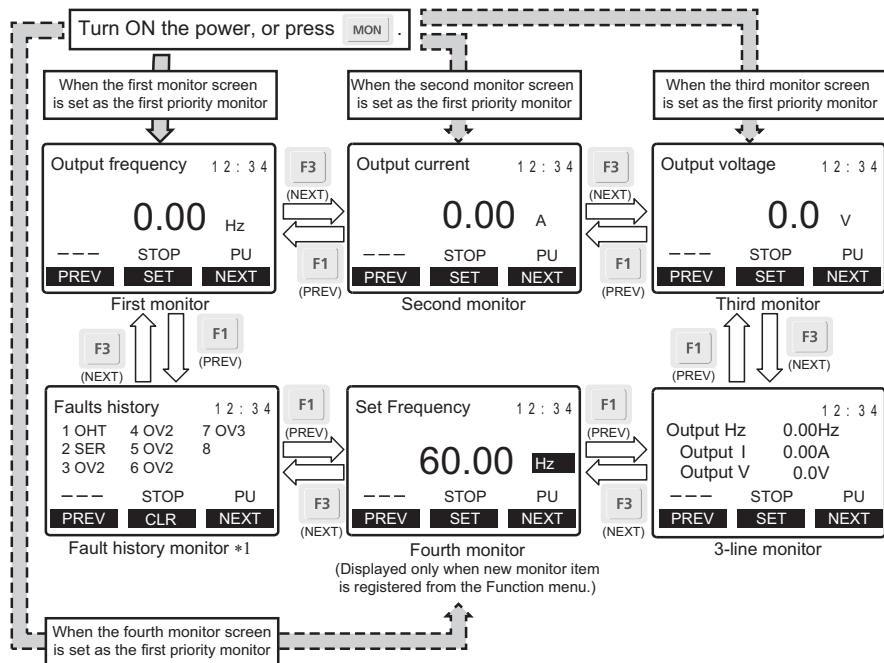

The monitor item/data on the first priority monitor and the top two monitor items/data among output current, output frequency, and output voltage are displayed in rows.

- *1 When the inverter stores 10 fault records, the fault history monitor screen are displayed as follows. For the maximum number of storable fault records, refer to the Instruction Manual of each inverter.

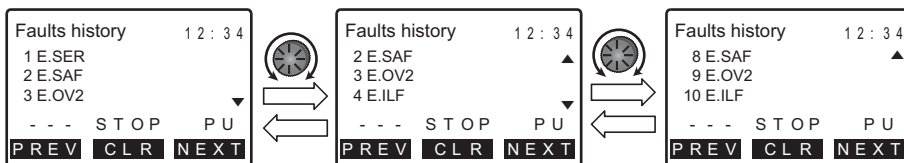

2.1.5 Changing the main monitor item from the Function menu

The monitor list is displayed when the Monitor selection in the Function menu is selected.

When a monitor item is set from the monitor list, the new monitor item is registered and displayed in the fourth monitor screen. (For the Function menu, refer to [page 34](#).)

2.1.6 Changing the main monitor item by parameter

Using **Pr.52 Operation panel main monitor selection**, the monitor item on the third monitor screen can be changed. However, the item on the second monitor screen is changed accordingly when "17" (load meter), "18" (motor excitation current), or "24" (motor load factor) is set in **Pr.52**.

2.1.7 Setting of the monitor data screen at power-ON (first priority monitor)

Set the monitor screen as the first priority monitor that is displayed first at power-ON or when **MON** is pressed.



While monitor data other than the fault history is displayed, press **F2 (SET)** to set the monitor data screen to be displayed first at power-ON, as the first priority monitor.



- For the details on the monitor items, refer to the Instruction Manual of the inverter.

2.2 Frequency setting

The frequency applied in the PU operation mode or external/PU combined operation mode (**Pr.79**="3") can be set.

To set the frequency, switch the monitor display from the Main monitor screen to the Frequency setting screen, turn  to input a frequency setting value, and press  to confirm the setting.

To switch back the monitor display from the Frequency setting screen to the Main monitor screen, press .

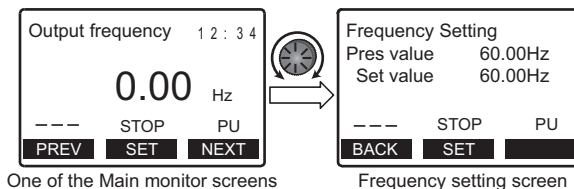

NOTE

- If the external start signal (STF or STR) is ON, the External operation mode cannot be switched to the PU operation mode.
- The screen can be switched to the Extended direct screen depending on the setting of **Pr.1000 Direct setting selection**. (Refer to [page 25](#).)

2.3 Direct setting

When setting **Pr.1000 Direct setting selection**, it is possible to switch from the Main monitor screen to the set point setting screen for PID action using . On each setting screen, turn to input a setting value, and press to confirm the setting.

Pr.1000 setting #1	Description
0 (Initial value)	Displays the Frequency setting screen.
1	Displays the Direct (set point setting) screen.
2	Displays the Direct (set point setting) screen and the Frequency setting screen.

*1 This setting is available only when the inverter supports this function. (Refer to [page 7](#).)

Example of screen switching and shifting when the PID control is enabled (**Pr.128** ≠ "0" or **Pr.753** ≠ "0")

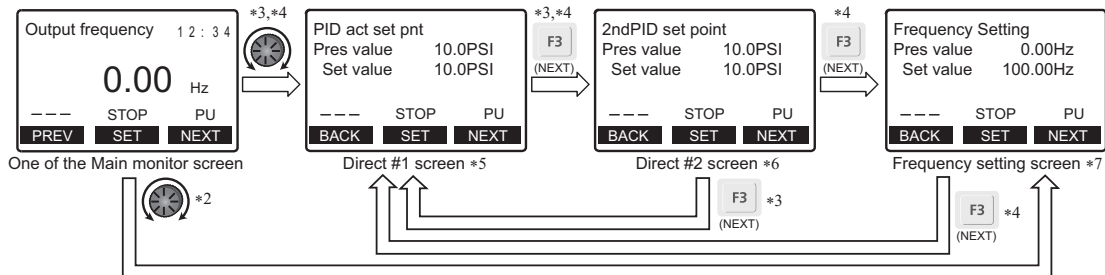

*2 When **Pr.1000**="0"

*3 When **Pr.1000**="1"

*4 When **Pr.1000**="2"

*5 Not displayed when PID control is disabled (**Pr.128**="0").

*6 Not displayed when the second PID control is disabled (**Pr.753**="0").

*7 Indication of [NEXT] is not displayed when **Pr.1000**="0".

To switch back the monitor display from the Direct screen or the Frequency setting screen to the Main monitor screen, press

(BACK)



2.4 Fault history indicator

Press  while the fault history is displayed to display the details of the fault.

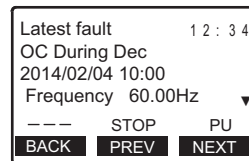
Press  to check details of the past faults stored in the inverter. For the maximum number of storable fault records, refer to the Instruction Manual of each inverter.



- How to clear the fault history

Press  while the fault history is displayed to display a confirmation screen for the fault history clear. Press  to clear the fault history and  to return to the fault history screen.

2.5 Setting and changing the parameter values

For the details on the parameters, refer to the Instruction Manual of the inverter.

2.5.1 Specifying the parameter number to change the set value

Example: To change the **Pr.8 Deceleration time** setting from 5 s to 180 s

1 Display the Quick menu and press . The parameter setting mode is activated.

Quick menu	Parameter No. input
→ Easy setup wizard	Parameter No.
Pr. list for App.	0000
Simple Pr. list	
--- STOP PU	--- STOP PU
LIST SET Pr SET	BACK SET →

↑ Parameter setting

2 Turn until [8] appears.

(Or, press to move [▲] to the target digit, and select the parameter number by turning .)

Press to display the present set value.

8 Dec. time
Pres value 5.0 sec
Set value 5.0 sec
0-3600
--- STOP PU
BACK SET NEXT

3 Turn to set the value to [180.0], and press . The set value is changed.

8 Dec. time
Pres value 5.0 sec
Set value 180.0 sec
Setting is completed
--- STOP PU
BACK NEXT

4 Press to display the next parameter.

9 Rated M Curr/THM
Pres value 4.25A
Set value 4.25A
0-500
--- STOP PU
BACK SET NEXT

2.5.2 Selecting the parameter from the Function group menu to change the set value

Example: To change the **F011 Deceleration time** setting from 5 s to 180 s

1 Display the Quick menu and press **F1** (LIST). The group parameter setting mode is activated.

Quick menu

- Easy setup wizard
- Pr. list for App.
- Simple Pr. list

--- STOP PU

LIST SET Pr SET

→

Function group Menu

- E Environm.setting
- F Acc/Dec
- D Opr/Freq command

--- STOP PU

BACK SET

Group parameter setting

2 Turn  to move the cursor to [F Acc/Dec], and press **F2** (SET). The setting items are displayed.

F Acc/Dec

- 0 Time setting
- 1 Pattern setting
- 2 Backlash

--- STOP PU

BACK SET

3 Turn  to move the cursor to [0 Time setting], and press **F2** (SET). The parameters on time setting are displayed.

F0 Time setting

- 00 Acc/Dec ref. F
- 01 Time increments
- 02 JOG Acc/Dcc time

--- STOP PU

BACK SET

4 Turn  to move the cursor to [11 Dec. time], and press **F2** (SET). The present set value is displayed.

F011 Dec. time

Pres value 5.0 sec

Set value 5.0 sec

0-3600

--- STOP PU

BACK SET NEXT

5 Turn  to set the value to [180.0], and press **F2** (SET). The set value is changed.

F011 Dec. time

Pres value 5.0 sec

Set value 180.0 sec

Setting is completed

--- STOP PU



BACK SET NEXT

NOTE

- When the inverter does not have any parameter related to the selected function, no parameter is displayed.



2.5.3 Selecting the parameter from Function menu to change the set value

Example: To change the **Pr.8 Deceleration time** setting from 5 s (initial value) to 180 s

1 Display the Function menu, turn  to move the cursor to the [Parameter list], and press . [Set parameter list] and [Initial value list] are displayed.



Parameter list
 ▶ Set parameter list
 Initial value list

--- STOP PU
 BACK SET

2 Turn  to move the cursor to [Initial value list], and press . [Initial value list] is displayed. (Press  to move the cursor ahead 100 parameters.)



Initial value list
 → 0 Torque 6.0
 1 Max. fr 120.0
 2 Min. fr 0.00

--- STOP PU
 BACK SET SKIP

3 Turn  to move the cursor to [8 Dec. time], and press . The present set value is displayed.

8 Dec. time
 Pres value 5.0 sec
 Set value 5.0 sec
 0-3600

--- STOP PU
 BACK SET NEXT

4 Turn  to set the value to [180.0], and press . The set value is changed.

8 Dec. time
 Pres value 5.0 sec
 Set value 180.0 sec
 Setting is completed



--- STOP PU
 BACK NEXT

5 Press  to display the next parameter.

9 Rated M Curr/THM
 Pres value 4.25A
 Set value 4.25A
 0-500

--- STOP PU
 BACK SET NEXT

NOTE

- If the parameter setting has been changed from the initial value, the set value can be changed from [Set parameter list]. Turn  to move the cursor to the target parameter, and press  to change the set value.

2.5.4 Precautions for writing the set value

- Basically, change the parameter setting while the inverter is stopped in the PU operation mode or combined operation. The parameter setting cannot be changed in the External operation mode or during operation. (The parameter setting can be read regardless of the operation mode.) Note that some parameters can be written even in the External operation mode or during operation. Refer to the Instruction Manual of the applied inverter.
- In the initial setting, "0" is set in **Pr.77 Parameter write selection**, and thus parameters can be written only while the inverter is stopped. (The parameters can be read even during the operation.) Note that some parameters can be always written. For the details of **Pr.77**, refer to the Instruction Manual of the inverter.
- In the following cases, set values cannot be written.
 - 1) When the parameter number selected does not exist in the parameter list
 - 2) When a value outside the setting range is entered
- If writing fails and [Setting Error] appears, press  to reset.

2.5.5 Displaying parameter descriptions (parameter information)

Holding down  while in the screen for setting parameter values displays a description of the parameter.

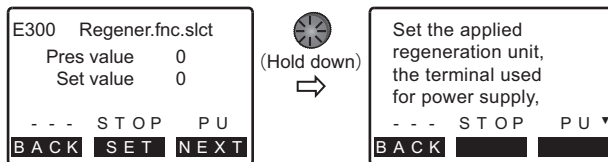

3.1 Quick menu

The parameters can be set by any one of the following methods.

Item	Description	Refer to page
Easy setup wizard *1	Initial setting can be completed with facility by following the wizard guide.	31
Parameter list by application [Pr. list for App.] *1	The parameters related to each application of the inverter can be set.	32
Simple setup list [Simple Pr. list]	Frequently-used functions (parameters) can be set.	33

*1 This setting is available only when the inverter supports this function. (Refer to [page 7](#).)

3.1.1 Easy setup wizard

Set the parameters required to run the inverter with the wizard guide through the stages.

Item
Induction motor / Magnet motor
Applied motor
Control method / Control mode
Motor capacity
Number of motor poles
Rated motor current
Rated motor voltage
Rated motor frequency
Base frequency
Base voltage

Item	
Maximum frequency	
Minimum frequency	
Acceleration time	
Deceleration time	
Inverter command	Start command
	Frequency command
Optimum excitation control	
Offline auto tuning	

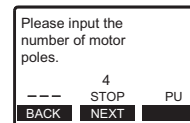
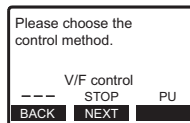
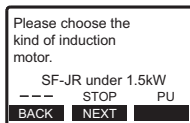
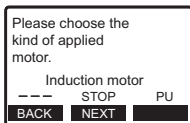

Screen examples of [Easy setup wizard]

NOTE

- The Easy setup wizard cannot be selected under the following conditions.
During inverter running, while the start command is ON, when parameter writing is disabled, or during password lock

3.1.2 Parameter list by application

Set the parameters related to each application such as for a fan, or a pump.

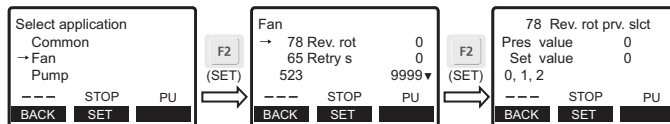

Screen examples of a parameter setting from [Pr. list for App.]

3.1.3 Simple setup list

Frequently-used functions (parameters) can be set.

Item		
Motor setting	Motor type	Induction motor
		Magnet motor
	Current	
	Voltage	Base frequency voltage
		Rated motor voltage
	Frequency	Base frequency
Rated motor frequency		
Auto tuning	Motor capacity	
	Number of motor poles	

Item	
Auto tuning	Control method selection
	Auto tuning setting
Minimum frequency	-
High speed maximum frequency	-
Acceleration time	-
Deceleration time	-
Operation mode selection	-
Language selection	-

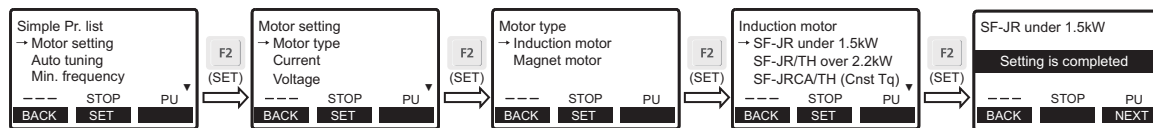

Screen examples of a parameter setting from [Simple Pr. list]

NOTE

- From [Language selection] in the Simple setup list, the setting of **Pr.145 PU display language selection** is not changed. In addition, changing the **Pr.145** setting does not affect the language displayed on the operation panel monitor.

3.2 Function menu

Various functions can be executed.

Function menu	Item	Refer to page
Monitor selection	Displays the monitor item list. Monitor item selected from the list can be set and changed on the Main monitor screen.	23
Parameter list	Displays [Set parameter list] and [Initial value list]. Set values can be changed from each list.	29
Parameter clear	Displays the parameter clear menu. "Parameter clear" and "All parameter clear" can be executed.	35
Inverter reset	Resets the inverter.	35
Terminal assignment	Displays the signals assigned to the I/O terminals of the control circuit and the ON/OFF status of the signals.	35
Parameter copy	Parameter copy (reading, writing, and verifying) can be performed.	36
Software version [S/W Version]	Displays the software control numbers of the inverter.	-
Option installation monitor [Option Instl Mntr]	Displays the plug-in options connected to the option connectors 1 to 3 of the inverter, and the optional terminal block installed on the inverter.	38
USB memory *1 [USB Memory Device]	Parameter settings and projects of the PLC function can be copied and written to/from a USB memory device, and verified.	39

*1 Available only when the inverter supports this function.

3.2.1 Parameter clear

"Parameter clear" and "All parameter clear" can be executed. Set the PU operation mode before execution.

- Parameter clear ... The settings of parameters except for calibration parameters and terminal function selection parameters are initialized.
- All parameter clear ... The settings of all the parameters, including calibration parameters and terminal function selection parameters, are initialized.

3.2.2 Inverter reset

Resets the inverter.

If the inverter's protective function has been activated and the inverter has tripped (output shut-off), the inverter reset can be

executed only by pressing  .

The inverter reset can also be executed by turning the inverter OFF and then ON or turning ON the RES signal. (For the details, refer to the Instruction Manual of the inverter.)

3.2.3 Terminal assignment

Displays the signals assigned to the I/O terminals of the control circuit and the ON/OFF status of the signals.

The terminal status of the plug-in option can be checked if a plug-in option FR-A8AY or FR-A8AR is installed.

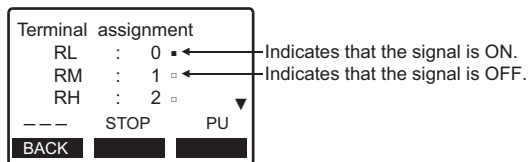







3.2.4 Parameter copy





(1) Copying parameter settings

Parameter settings of an inverter can be read, and the settings of up to three inverters can be stored in the copy area of the FR-LU08(-01). The stored parameter settings can be copied to other inverters of same series.

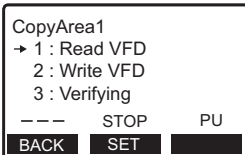
- To read the parameter settings of the inverter and store them to the FR-LU08(-01)

1	Connect the FR-LU08(-01) to the source inverter.
2	Display the Function menu, turn  to move the cursor to [Parameter copy], and press  (SET).
3	Turn  to move the cursor to the copy area for parameter setting storage, and press  (SET). (Screen example when parameter copy is enabled for up to three inverters. Not displayed when parameter copy is enabled for only one inverter.)
4	Turn  to move the cursor to [1: Read VFD], and press  (SET).





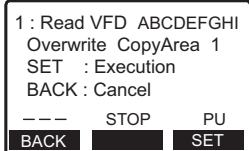



5	A name (up to 9 letters) can be entered for the selected area. Turn  to select "0 to 9", "A to Z", ".", "_", "-", "/" or "(space)". Press  (→) to move the cursor. Press  (SET) after completing the input.
6	A confirmation screen appears for overwriting the selected area. Press  (SET) to execute the parameter setting storage.



- The number of inverters whose parameter settings can be copied differs as follows.

Inverter	Number of inverters
FR-A800 series	3
FR-F800 series	
FR-E800 series (except for the FR-E800-(SC)E)	1

- To write the parameter settings stored in the FR-LU08(-01) to an inverter

1	Connect the FR-LU08(-01) to the target inverter.
2	Display the Function menu, turn  to move the cursor to [Parameter copy], and press  .
3	Turn  to move the cursor to the target copy area, and press  . (Screen example when parameter copy is enabled for up to three inverters. Not displayed when parameter copy is enabled for only one inverter.)
4	Turn  to move the cursor to [2: Write VFD], and press  .
5	A confirmation screen appears for writing the parameters. Press  to write the parameters.

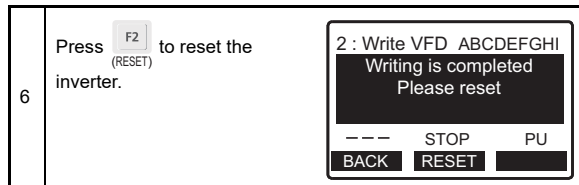
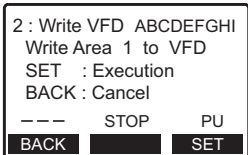
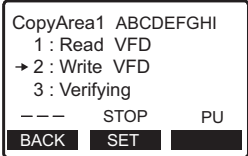
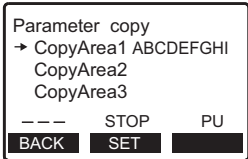







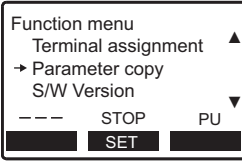

NOTE

- When the data in the FR-LU08(-01) is overwritten, the previous data is deleted.
- When parameter settings of an inverter is stored in the FR-LU08(-01) and the inverter is of the series for which parameter copy of one inverter is supported by the FR-LU08(-01), storing parameter settings of another inverter to any of areas 1 to 3 will delete the former data when the inverter is of the series for which parameter copy of three inverters is supported by the FR-LU08(-01).
- Parameter settings of inverters of the series for which the FR-LU08(-01) supports parameter copy of three inverters will be deleted by storing parameter settings of another inverter of the series for which the FR-LU08(-01) supports parameter copy of one inverter.
- Once started, reading or writing cannot be stopped halfway.
- Parameter settings stored in the operation panel are not deleted by turning OFF the power.

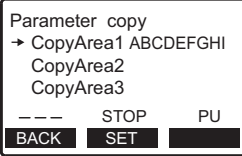
(2) Verifying the parameters

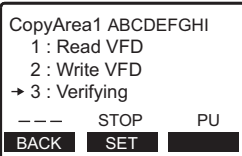
The copied parameter settings stored in the FR-LU08(-01) and those in an inverter can be verified.

1	Copy the parameter settings of the source inverter to the FR-LU08(-01). (Refer to page 36.)
2	Connect the FR-LU08(-01) to the target inverter.
3	<p>Display the Function menu, turn  to move the cursor to [Parameter copy], and press .</p> 
4	<p>Turn  to select the target copy area, and press .</p> <p>(Screen example when parameter copy is enabled for up to three inverters. Not displayed when parameter copy is enabled for only one inverter.)</p> 
5	<p>Turn  to move the cursor to [3: Verifying], and press .</p> 
6	A confirmation screen appears for verification. Press  to execute the verification.

If a verification error occurs, the verification is stopped and an error screen appears.

7 Press  to continue the verification.

Press  to end the verification.

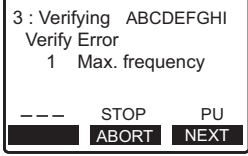

NOTE

- If an error occurs in verification on items other than parameters, such as the setting frequency, only [Verify Error] is displayed.

3.2.5 Option installation monitor

Displays the connection status of option connectors (of up to 6 letters). When no option is connected, [----] is displayed.

Turn  to display the installed terminal block option (of up to 20 letters).

(Example) When FR-A800 is connected

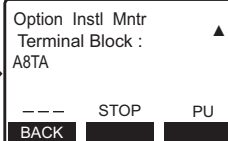



Diagram showing the transition between the two screens using the directional pad.

3.2.6 USB memory







Parameter settings and projects of the PLC function can be copied from and written to a USB memory device, and verified.



NOTE

- [INV] on the monitor display indicates the inverter.
- [PLC] on the monitor display indicates the programmable controller.
- This function is available only for the inverter with a USB connector. For details of the USB communication, refer to the Instruction Manual of each inverter.

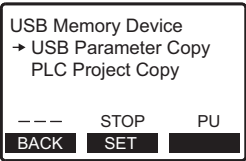

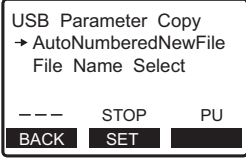

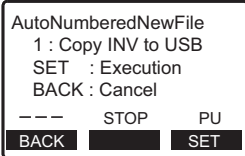

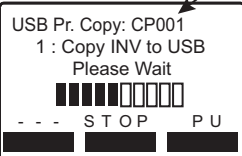
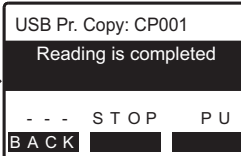

(1) Copying parameter settings to a USB memory device



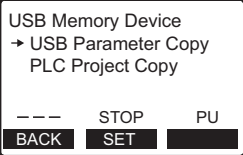

- To copy parameter settings as a new file (numbered)

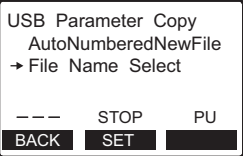
1	Connect the FR-LU08(-01) and a USB memory device to the source inverter.
2	Display the Function menu, turn  to move the cursor to [USB Memory Device], and press  (SET).
3	Turn  to move the cursor to [USB Parameter Copy], and press  (SET). 
4	Turn  to move the cursor to [AutoNumberedNewFile], and press  (SET). (If [File Name Select] has been selected, a file number selection screen appears.) 

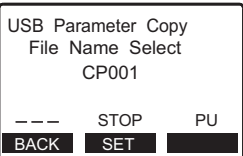



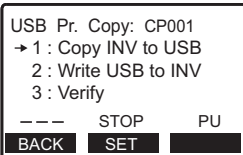

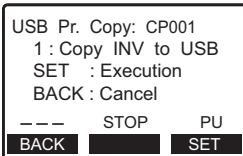

5	A confirmation screen appears for execution. 
6	Press  (SET) to execute the copy. <p>The file number is automatically assigned from the inverter.</p>  





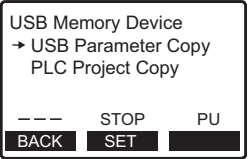

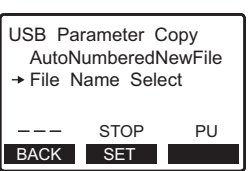
- To copy parameter settings to an existing file

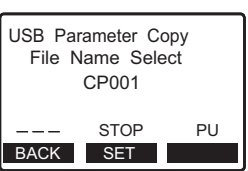
1	Connect the FR-LU08(-01) and a USB memory device to the source inverter.
2	Display the Function menu, turn  to move the cursor to [USB Memory Device], and press  (SET).
3	Turn  to move the cursor to [USB Parameter Copy], and press  (SET). 
4	Move the cursor to [File Name Select], and press  (SET). 
5	A file name selection screen appears. Turn  to move the cursor to the target file, and press  (SET). 



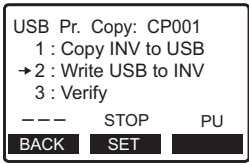

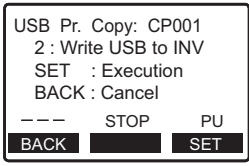

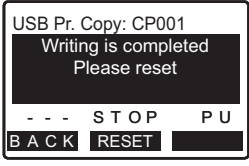

6	Turn  to move the cursor to [1: Copy INV to USB], and press  (SET). 
7	A confirmation screen appears for execution. Press  (SET) to execute the copy. 





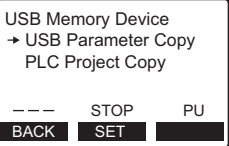

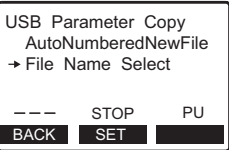
(2) Writing the parameter settings stored on a USB memory device to an inverter

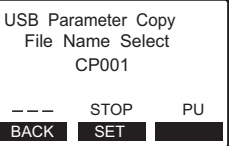
1	Connect the FR-LU08(-01) and a USB memory device to the target inverter.
2	Display the Function menu, turn  to move the cursor to [USB Memory Device], and press  (SET).
3	Turn  to move the cursor to [USB Parameter Copy], and press  (SET). 
4	Move the cursor to [File Name Select], and press  (SET). 
5	A file name selection screen appears. Turn  to move the cursor to the target file, and press  (SET). 

6	Turn  to move the cursor to [2: Write USB to INV], and press  (SET). 
7	A confirmation screen appears for execution. Press  (SET) to write the parameters. 
8	Press  (RESET) to reset the inverter. 

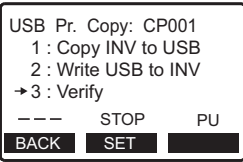
(3) Verifying the parameter settings stored on a USB memory device with those in an inverter

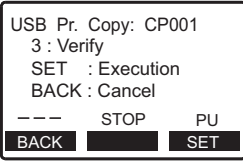

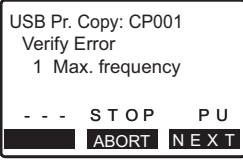







1	Copy the parameter settings of the source inverter to a USB memory device. (Refer to page 39 .)
2	Connect the FR-LU08(-01) and a USB memory device to the target inverter.
3	Display the Function menu, turn  to move the cursor to [USB Memory Device], and press  (SET).
4	Turn  to move the cursor to [USB Parameter Copy], and press  (SET). 
5	Move the cursor to [File Name Select], and press  (SET). 
6	A file name selection screen appears. Turn  to move the cursor to the target file, and press  (SET). 



7	Turn  to move the cursor to [3: Verify], and press  (SET). 
8	A confirmation screen appears for execution. Press  (SET) to execute the verification. 
9	If a verification error occurs, the verification is stopped and an error screen appears. Press  (NEXT) to continue the verification. Press  (ABORT) to end the verification. 

NOTE









- If an error occurs in verification on items other than parameters, such as the setting frequency, only [Verify Error] is displayed.



(4) Copying a project of the PLC function to a USB memory device

1	Connect the FR-LU08(-01) and a USB memory device to the source inverter.
2	Display the Function menu, turn  to move the cursor to [USB Memory Device], and press  .
3	Turn  to move the cursor to [PLC Project Copy], and press  . <div style="border: 1px solid black; padding: 5px; margin-top: 10px;"> USB Memory Device USB Parameter Copy → PLC Project Copy --- STOP PU BACK SET  </div>
4	A file name selection screen appears. Turn  to move the cursor to the target file, and press  . <div style="border: 1px solid black; padding: 5px; margin-top: 10px;"> PLC Project Copy Folder Name Select PRG01 --- STOP PU BACK SET  </div>
5	Turn  to move the cursor to [1: Copy INV to USB], and press  . <div style="border: 1px solid black; padding: 5px; margin-top: 10px;"> PLC Prjct Copy: PRG01 → 1 : Copy INV to USB 2 : Write USB to INV 3 : Verify --- STOP PU BACK SET  </div>







6	<p>A confirmation screen appears for execution.</p> <p>Press  to execute the copy.</p>	<pre> PLC Prjct Copy: PRG01 1 : Copy INV to USB SET : Execution BACK : Cancel --- STOP PU BACK  SET </pre>
---	---	---





(5) Writing a project of the PLC function stored on a USB memory device to an inverter

1	Connect the FR-LU08(-01) and a USB memory device to the target inverter.
2	Display the Function menu, turn  to move the cursor to [USB Memory Device], and press  .
3	Turn  to move the cursor to [PLC Project Copy], and press  . <div style="border: 1px solid black; padding: 5px; width: fit-content; margin-left: 200px;"> USB Memory Device USB Parameter Copy → PLC Project Copy --- STOP PU BACK SET </div>
4	A file name selection screen appears. Turn  to move the cursor to the target file, and press  .
5	Turn  to move the cursor to [2: Write USB to INV], and press  .
	<div style="border: 1px solid black; padding: 5px; width: fit-content; margin-left: 200px;"> PLC Prjct Copy: PRG01 1 : Copy INV to USB → 2 : Write USB to INV 3 : Verify --- STOP PU BACK SET </div>

6	A confirmation screen appears for execution. Press  to write the project. <div style="border: 1px solid black; padding: 5px; width: fit-content; margin-left: 200px;"> PLC Prjct Copy: PRG01 2 : Write USB to INV SET : Execution BACK : Cancel --- STOP PU BACK SET </div>
7	Press  to reset the inverter. <div style="border: 1px solid black; padding: 5px; width: fit-content; margin-left: 200px;"> PLC Prjct Copy: PRG01 Writing is completed Please reset - - - S T O P P U B A C K RESET </div>

(6) Verifying the project of the PLC function stored on a USB memory device with that of the inverter

1	Copy the project of the source inverter to a USB memory. (Refer to page 44 .)
2	Connect the FR-LU08(-01) and a USB memory device to the target inverter.
3	Display the Function menu, turn  to move the cursor to [USB Memory Device], and press  .
4	Turn  to move the cursor to [PLC Project Copy], and press  . <div style="border: 1px solid black; padding: 5px; width: fit-content; margin-left: 200px;"> USB Memory Device USB Parameter Copy → PLC Project Copy --- STOP PU BACK SET </div>
5	A file name selection screen appears. Turn  to move the cursor to the target file, and press  . <div style="border: 1px solid black; padding: 5px; width: fit-content; margin-left: 200px;"> PLC Project Copy Folder Name Select PRG01 --- STOP PU BACK SET </div>

6	Turn  to move the cursor to [3: Verify], and press  . <div style="border: 1px solid black; padding: 5px; width: fit-content; margin-left: 200px;"> PLC Prjct Copy: PRG01 1 : Copy INV to USB 2 : Write USB to INV → 3 : Verify --- STOP PU BACK SET </div>
7	A confirmation screen appears for execution. Press  to execute the verification. <div style="border: 1px solid black; padding: 5px; width: fit-content; margin-left: 200px;"> PLC Prjct Copy: PRG01 3 : Verify SET : Execution BACK : Cancel --- STOP PU BACK SET </div>
8	If a verification error occurs, the verification is stopped and an error screen appears. Press  to return to the screen of step 7. <div style="border: 1px solid black; padding: 5px; width: fit-content; margin-left: 200px;"> PLC Prjct Copy: PRG01 Verify Error - - - S T O P P U B A C K </div>

4 CHECK FIRST WHEN YOU HAVE TROUBLE

4.1 Troubleshooting

If a fault occurs and the product fails to operate properly, locate the cause of the fault and take proper corrective action by referring to the troubleshooting table below. Contact your local sales representative if the corresponding information is not found in the table, the inverter has problem, or the component parts are damaged.

Status	Possible causes	Check point	Corrective action
The LCD or backlight of the operation panel is OFF.	Connection fault of the operation panel	Check that the operation panel is properly connected. Check that the PU cable is fully inserted into the PU connector.	Check the connection of the operation panel and the PU cable.
	The setting of Pr.991 PU contrast adjustment has changed from the initial value.	Check the Pr.991 setting.	Using the FR-DU08(-01), return the setting of Pr.991 to the initial value.
During inverter reset, the following screen remains. <div style="border: 1px solid black; padding: 5px; width: fit-content; margin-top: 10px;">Ready PU to Inverter Comms, Error INV. Reset ON</div>	Connection fault of the operation panel	Check that the operation panel is properly connected. Check that the PU cable is fully inserted into the PU connector.	Check the connection of the operation panel and the PU cable.
	The RES signal is ON.	Check the terminal RES.	Turn OFF the terminal RES.

5 SPECIFICATIONS

5.1 Standard specifications

Item	Specifications	
Surrounding air temperature	-10°C to +50°C (non-freezing) *1	
Surrounding air humidity	FR-LU08	90% RH or less (non-condensing)
	FR-LU08-01	95% RH or less (non-condensing)
Storage temperature	-20°C to +65°C *2	
Atmosphere	Indoors (free from corrosive gas, flammable gas, oil mist, dust and dirt)	
Altitude/vibration	Maximum 2500 m, 5.9 m/s ² or less at 10 to 55 Hz (directions of X, Y, Z axes)	
Power supply	Power input from the inverter	
Connection	Installed to the inverter or connected to the inverter by a dedicated cable *3	
Display	Liquid crystal display (LCD)	
Data retention	Built-in EEPROM	
Number of write times	Maximum 100,000 times	
Mass	Approximately 300 g	

*1 At low temperatures of less than 0°C, the LCD may be slower in operation.

At high temperatures, the life of the LCD and battery may become shorter.

*2 Temperature applicable for a short time, such as in transit

*3 The FR-LU08-01 is rated IP55 only when it is installed on the inverter.

NOTE

- Do not expose the LCD to direct sunlight.
- During transportation, avoid applying load to the LCD.

5.2 Outline and enclosure cut dimensions

◆ FR-LU08

<Outline drawing>

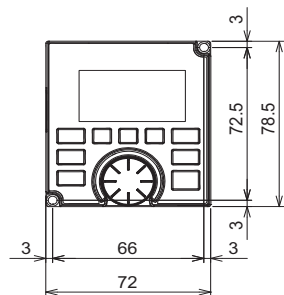

<Panel cutting dimension drawing>

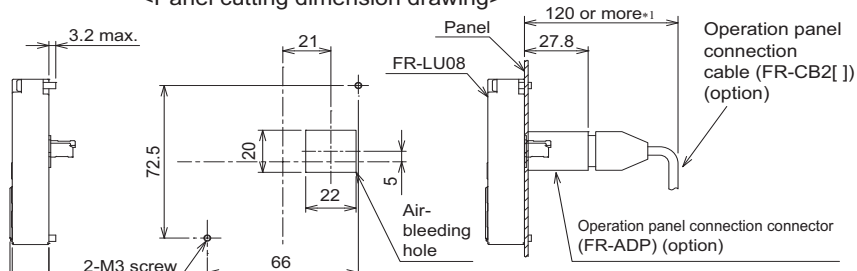

*1 Denotes the combined length of the two connectors when the operation panel connection cable (FR-CB2[]) is connected to the operation panel connection connector (FR-ADP). The combined length of the two connectors will be different if other (3rd party) operation panel connection cables are used.

(Unit : mm)

◆ FR-LU08-01

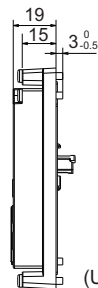
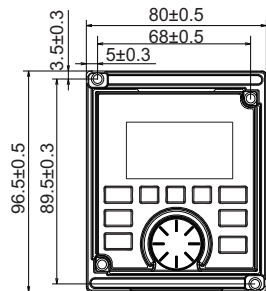

(Unit : mm)

NOTE

- The FR-LU08-01 cannot be installed on enclosure surfaces.

Appendix

Appendix 1 Disposing of equipment in EU countries

- The symbol shown below, which is printed on products for EU countries, means that electronic equipment at the end of its life should be disposed of separately from household waste.
- Please, dispose of this equipment at your local community waste collection/recycling centre if it is to be disposed of in EU countries.
- In the European Union, there are separate collection systems for used electronic products.
- Please, help us to conserve the environment we live in.



NOTE

- This symbol is for EU countries only.
This symbol is according to the directive 2006/66/EC Article 20 Information for end-users, Article 21 Labelling, and Annex II.

Appendix 2 Instructions for compliance with the EU Directives

The EU Directives are issued to standardize different national regulations of the EU Member States and to facilitate free movement of the equipment, whose safety is ensured, in the EU territory.

Since 1996, compliance with the EMC Directive that is one of the EU Directives has been legally required. Since 1997, compliance with the Low Voltage Directive, another EU Directive, has been also legally required. When a manufacturer confirms its equipment to be compliant with the EMC Directive and the Low Voltage Directive, the manufacturer must declare the conformity and affix the CE marking.



- The authorized representative in the EU
The authorized representative in the EU is shown below.
Name: Mitsubishi Electric Europe B.V.
Address: Mitsubishi-Electric-Platz 1, 40882 Ratingen, Germany

◆ EMC Directive

We declare that this product conforms with the EMC Directive when installed in a compatible inverter, and affix the CE marking on the packaging plate.

- EMC Directive: 2014/30/EC
- Standard(s): EN 61800-3:2004+A1:2012 (Second environment / PDS Category "C3")

◆ Note

- To install and wire the inverter, refer to the "Instructions for compliance with the EU Directives" in the Instruction Manual enclosed with the inverter.
- Ensure that the finalized system which includes an inverter complies with the EMC Directive.



Appendix 3 Instructions for EAC

The product certified in compliance with the Eurasian Conformity has the EAC marking on the packaging plate.

Note: EAC marking

In 2010, three countries (Russia, Belarus, and Kazakhstan) established a Customs Union for the purposes of revitalizing the economy by forming a large economic bloc by abolishing or reducing tariffs and unifying regulatory procedures for the handling of articles.

Products to be distributed over these three countries of the Customs Union must comply with the Customs Union Technical Regulations (CU-TR), and the EAC marking must be affixed to the products.

For information on the country of origin, manufacture year and month, and authorized sales representative (importer) in the CU area of this product, refer to the following:

- Country of origin indication

Check the package of this product.

Example: MADE IN JAPAN

- Manufactured year and month

Check the SERIAL number indicated on this product.

□□□□	○	○	○○○○○
Symbol	Year	Month	Control number
SERIAL			

The SERIAL consists of four symbols, two characters indicating the production year and month, and five characters indicating the control number. The last digit of the production year is indicated as the Year, and the Month is indicated by 1 to 9, X (October), Y (November), or Z (December).

- Authorized sales representative (importer) in the CU area

The authorized sales representative (importer) in the CU area is shown below.

Name: Mitsubishi Electric (Russia) LLC

Address: 52, bld 1 Kosmodamianskaya Nab 115054, Moscow, Russia

Phone: +7 (495) 721-2070

Fax: +7 (495) 721-2071

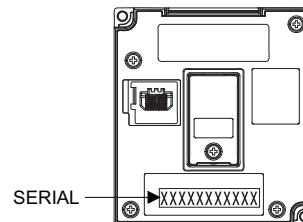

Appendix 4 Restricted Use of Hazardous Substances in Electronic and Electrical Products

The mark of restricted use of hazardous substances in electronic and electrical products is applied to the product as follows based on the "Management Methods for the Restriction of the Use of Hazardous Substances in Electrical and Electronic Products" of the People's Republic of China.

电器电子产品有害物质限制使用标识要求



本产品中所含有的有害物质的名称、含量、含有部件如下表所示。

- 产品中所含有害物质的名称及含量

部件名称*2	有害物质*1					
	铅(Pb)	汞(Hg)	镉(Cd)	六价铬(Cr(VI))	多溴联苯(PBB)	多溴二苯醚(PBDE)
电路板组件 (包括印刷电路板及其构成的零部件, 如电阻、电容、集成电路、连接器等)、电子部件	×	○	×	○	○	○
金属壳体、金属部件	×	○	○	○	○	○
树脂壳体、树脂部件	○	○	○	○	○	○
螺丝、电线	○	○	○	○	○	○

上表依据SJ/T11364的规定编制。

○：表示该有害物质在该部件所有均质材料中的含量均在GB/T26572规定的限量要求以下。

×：表示该有害物质在该部件的至少一种均质材料中的含量超出GB/T26572规定的限量要求。

*1 即使表中记载为 ×，根据产品型号，也可能会有有害物质的含量为限制值以下的情况。

*2 根据产品型号，一部分部件可能不包含在产品中。

MEMO

MEMO

REVISIONS

*The manual number is given on the bottom left of the back cover.

Revision date	*Manual number	Revision
Jun. 2014	IB(NA)-0600539ENG-A	First edition
Dec. 2014	IB(NA)-0600539ENG-B	Added • FR-LU08-01
May 2015	IB(NA)-0600539ENG-C	Added • Easy setup wizard, Parameter list by application, Extended direct setting
Oct. 2015	IB(NA)-0600539ENG-D	Edited • Language selection
Jun. 2018	IB(NA)-0600539ENG-E	Added • Parameter information
Nov. 2018	IB(NA)-0600539ENG-F	Edited • Language selection
May 2020	IB(NA)-0600539ENG-G	Edited • Compatibility with the FR-E800 series (except for the FR-E800-(SC)E)

INVERTER

mitsubishi electric corporation

HEAD OFFICE: TOKYO BUILDING 2-7-3, MARUNOUCHI, CHIYODA-KU, TOKYO 100-8310, JAPAN